

Features

Design flexibility – Available in a variety sizes and colors to suit most any application.
 Durable Acrylic Panel – Offers sturdy mechanical support and device stability.
 Long lifetimes – Typically 100k hours.
 Low power consumption – Uses far less power than standard incandescent EL or CCFL light sources.

Applications

Backlighting LCD Displays; Panels and Symbols
 Illumination of Large Surface Areas

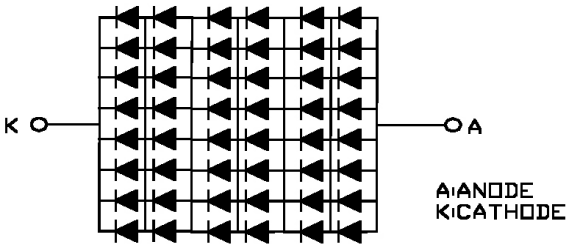

LED NUMBERS: 8X6=48

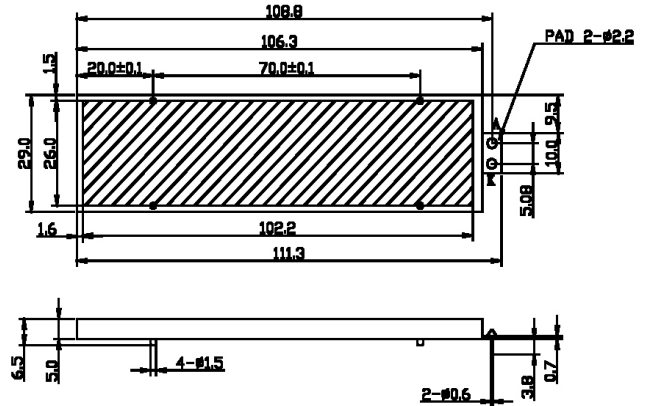

Electrical and Optical Characteristics (Ta=25°C)

Part Number	PWL nm λP	Material	View Angle 2θ _{1/2}	Luminous Intensity I _v				Forward Voltage V _F			
				min.	typ.	max.	IF@	min.	typ.	max.	IF@
MTBL2135-G	574	InGaAlP	-	-	240.00	-	20mA	-	12.20	-	20mA
-	nm	-	deg	mcd				-	V		-